

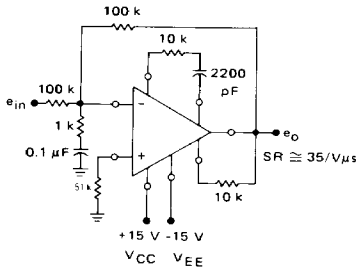
**MC1439**  
**MC1539**

**UNCOMPENSATED OPERATIONAL AMPLIFIER**

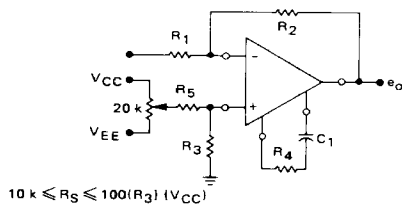
... designed for use as a summing amplifier, integrator, or amplifier with operating characteristics as a function of the external feedback components.

- Low Input Offset Voltage — 3.0 mV max
- Low Input Offset Current — 60 nA max
- Large Power-Bandwidth — 20 Vp-p Output Swing at 20 kHz min
- Output Short-Circuit Protection
- Input Over-Voltage Protection
- Class AB Output for Excellent Linearity
- High Slew Rate — 34 V/ $\mu$ s typ

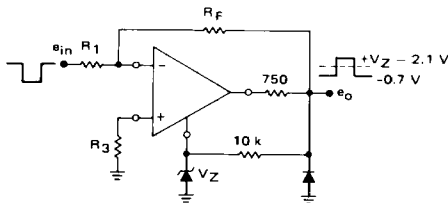
**FIGURE 1 — HIGH SLEW-RATE INVERTER**



**FIGURE 2 — OUTPUT NULLING CIRCUIT**



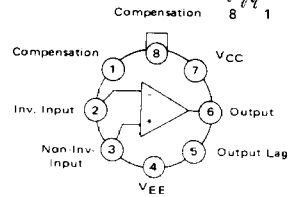
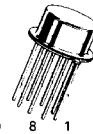
**FIGURE 3 — OUTPUT LIMITING CIRCUIT**



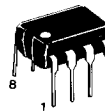
**OPERATIONAL AMPLIFIER**

**SILICON MONOLITHIC**  
**INTEGRATED CIRCUIT**

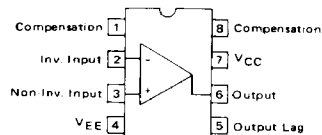
**G SUFFIX**  
**METAL PACKAGE**  
**CASE 601**



(Top View)



**P1 SUFFIX**  
**PLASTIC PACKAGE**  
**CASE 626**  
**(MC1439 Only)**



(Top View)

**ORDERING INFORMATION**

Device	Temperature Range	Package
MC1439G	0°C to +70°C	Metal Can
MC1439P1	0°C to +70°C	Plastic DIP
MC1539G	-55°C to +125°C	Metal Can

# MC1439, MC1539

ELECTRICAL CHARACTERISTICS ( $V_{CC} = +15$  Vdc,  $V_{EE} = -15$  Vdc,  $T_A = +25^\circ\text{C}$  unless otherwise noted.)

Characteristic	Symbol	MC1539			MC1439			Unit
		Min	Typ	Max	Min	Typ	Max	
Input Bias Current ( $T_A = +25^\circ\text{C}$ ) ( $T_A = T_{low}$ ①)	$I_{IB}$	—	0.20	0.50	—	0.20	1.0	$\mu\text{A}$
		—	0.23	0.70	—	0.23	1.5	
Input Offset Current ( $T_A = T_{low}$ ) ( $T_A = +25^\circ\text{C}$ ) ( $T_A = T_{high}$ ①)	$ I_{IO} $	—	—	75	—	—	150	nA
		—	20	60	—	20	100	
		—	—	75	—	—	150	
Input Offset Voltage ( $T_A = +25^\circ\text{C}$ ) ( $T_A = T_{low}, T_{high}$ )	$ V_{IO} $	—	1.0	3.0	—	2.0	7.5	mV
		—	—	4.0	—	—	—	
Average Temperature Coefficient of Input Offset Voltage ( $T_A = T_{low}$ to $T_{high}$ ) ( $R_S = 50 \Omega$ ) ( $R_S \leq 10 \text{ k}\Omega$ )	$ TCV_{IO} $	—	3.0	—	—	3.0	—	$\mu\text{V}/^\circ\text{C}$
		—	5.0	—	—	5.0	—	
Input Impedance ( $f = 20 \text{ Hz}$ )	$z_{in}$	150	300	—	100	300	—	$\text{k}\Omega$
Input Common-Mode Voltage Range	$V_{ICR}$	+11	+12	—	$\pm 11$	+12	—	$V_{pk}$
Equivalent Input Noise Voltage ( $R_S = 10 \text{ k}\Omega$ , Noise Bandwidth = 1.0 Hz, $f = 1.0 \text{ kHz}$ )	$e_n$	—	30	—	—	30	—	$\text{nV}/(\text{Hz})^{1/2}$
Common-Mode Rejection Ratio ( $f = 1.0 \text{ kHz}$ )	CMRR	80	110	—	80	110	—	dB
Open-Loop Voltage Gain ( $V_O = \pm 10 \text{ V}$ , $R_L = 10 \text{ k}\Omega$ , $R_S = \infty$ ) ( $T_A = +25^\circ\text{C}$ to $T_{high}$ ) ( $T_A = T_{low}$ )	$A_{VOL}$	50,000	120,000	—	15,000	100,000	—	—
		25,000	100,000	—	15,000	100,000	—	
Power Bandwidth ( $A_v = 1$ , THD $\leq 5\%$ , $V_O = 20 \text{ V}_{p-p}$ ) ( $R_L = 2.0 \text{ k}\Omega$ ) ( $R_L = 1.0 \text{ k}\Omega$ , $R_S = 10 \text{ k}\Omega$ )	PBW	—	—	—	10	50	—	kHz
		20	50	—	—	—	—	
Step Response { Gain = 1000, no overshoot, $R_1 = 1.0 \text{ k}\Omega$ , $R_2 = 1.0 \text{ M}\Omega$ , $R_3 = 1.0 \text{ k}\Omega$ , $R_4 = 30 \text{ k}\Omega$ , $R_5 = 10 \text{ k}\Omega$ , $C_1 = 1000 \text{ pF}$ }	$t_{THL}$	—	130	—	—	130	—	ns
	$t_{pd}$	—	190	—	—	190	—	ns
	SR	—	6.0	—	—	6.0	—	$\text{V}/\mu\text{s}$
{ Gain = 1000, 15% overshoot, $R_1 = 1.0 \text{ k}\Omega$ , $R_2 = 1.0 \text{ M}\Omega$ , $R_3 = 1.0 \text{ k}\Omega$ , $R_4 = 0$ , $R_5 = 10 \text{ k}\Omega$ , $C_1 = 10 \text{ pF}$ }	$t_{THL}$	—	80	—	—	80	—	ns
	$t_{pd}$	—	100	—	—	100	—	ns
	SR	—	14	—	—	14	—	$\text{V}/\mu\text{s}$
{ Gain = 100, no overshoot, $R_1 = 1.0 \text{ k}\Omega$ , $R_2 = 100 \text{ k}\Omega$ , $R_3 = 1.0 \text{ k}\Omega$ , $R_4 = 10 \text{ k}\Omega$ , $R_5 = 10 \text{ k}\Omega$ , $C_1 = 2200 \text{ pF}$ }	$t_{THL}$	—	60	—	—	60	—	ns
	$t_{pd}$	—	100	—	—	100	—	ns
	SR	—	34	—	—	34	—	$\text{V}/\mu\text{s}$
{ Gain = 10, 15% overshoot, $R_1 = 1.0 \text{ k}\Omega$ , $R_2 = 10 \text{ k}\Omega$ , $R_3 = 1.0 \text{ k}\Omega$ , $R_4 = 1.0 \text{ k}\Omega$ , $R_5 = 10 \text{ k}\Omega$ , $C_1 = 2200 \text{ pF}$ }	$t_{THL}$	—	120	—	—	120	—	ns
	$t_{pd}$	—	80	—	—	80	—	ns
	SR	—	6.25	—	—	6.25	—	$\text{V}/\mu\text{s}$
{ Gain = 1, 15% overshoot, $R_1 = 10 \text{ k}\Omega$ , $R_2 = 10 \text{ k}\Omega$ , $R_3 = 5.0 \text{ k}\Omega$ , $R_4 = 390 \Omega$ , $R_5 = 10 \text{ k}\Omega$ , $C_1 = 2200 \text{ pF}$ }	$t_{THL}$	—	160	—	—	160	—	ns
	$t_{pd}$	—	80	—	—	80	—	ns
	SR	—	4.2	—	—	4.2	—	$\text{V}/\mu\text{s}$
Output Impedance ( $f = 20 \text{ Hz}$ )	$z_o$	—	4.0	—	—	4.0	—	$\text{k}\Omega$
Output Voltage Swing ( $R_L = 2.0 \text{ k}\Omega$ , $f = 1.0 \text{ kHz}$ ) ( $R_L = 1.0 \text{ k}\Omega$ , $f = 1.0 \text{ kHz}$ )	$V_O$	—	—	—	+10	+13	—	$V_{pk}$
		$\pm 10$	+13	—	—	—	—	
Positive Supply Rejection Ratio ( $V_{EE}$ constant, $R_S = \infty$ )	PSRR+	—	50	150	—	50	200	$\mu\text{V}/\text{V}$
Negative Supply Rejection Ratio ( $V_{CC}$ constant, $R_S = \infty$ )	PSRR-	—	50	150	—	50	200	$\mu\text{V}/\text{V}$
Power Supply Current ( $V_O = 0$ )	$I_{CC}$ $I_{EE}$	—	3.0	5.0	—	3.0	6.7	$\text{mA}_{dc}$
		—	3.0	5.0	—	3.0	6.7	

①  $T_{low} = 0^\circ\text{C}$  for MC1439       $T_{high} = +70^\circ\text{C}$  for MC1439  
 —  $55^\circ\text{C}$  for MC1539      +  $125^\circ\text{C}$  for MC1539

# MC1439, MC1539

MAXIMUM RATINGS ( $T_A = +25^\circ\text{C}$  unless otherwise noted.)

Rating	Symbol	Value	Unit
Power Supply Voltage	$V_{CC}$ $V_{EE}$	+18 +18	Vdc
Differential Input Voltage Range	$V_{IDR}$	$\pm(V_{CC} +  V_{EE} )$	Vdc
Common-Mode Input Voltage Range	$V_{ICR}$	$+V_{CC}, - V_{EE} $	Vdc
Load Current	$I_L$	15	mA
Output Short-Circuit Duration	$t_s$	Continuous	
Power Dissipation (Package Limitation)	$P_D$		
Metal Package		680	mW
Derate above $T_A = +25^\circ\text{C}$		4.6	mW/ $^\circ\text{C}$
Plastic Dual In-Line Packages MC1439		625	mW
Derate above $T_A = +25^\circ\text{C}$		5.0	mW/ $^\circ\text{C}$
Operating Temperature Range	$T_A$	-55 to +125 0 to +70	$^\circ\text{C}$
Storage Temperature Range	$T_{stg}$	-65 to +150 -55 to +125	$^\circ\text{C}$
Metal Packages			
Plastic Packages			

2

FIGURE 4 – EQUIVALENT CIRCUIT SCHEMATIC

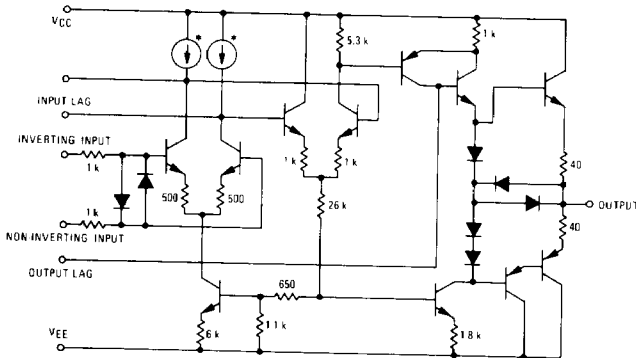
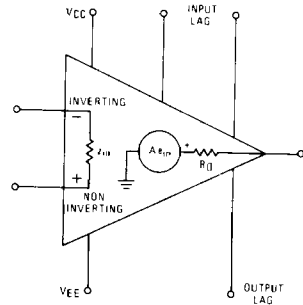


FIGURE 5 – EQUIVALENT CIRCUIT

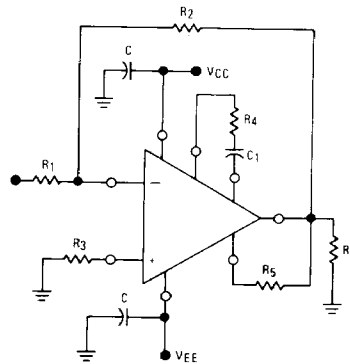


TYPICAL OUTPUT CHARACTERISTICS

$V_{CC} = +15 \text{ Vdc}$ ,  $V_{EE} = -15 \text{ Vdc}$ ,  $T_A = +25^\circ\text{C}$

FIGURE NO.	CURVE NO.	VOLTAGE GAIN	TEST CONDITIONS (FIGURE 6)					
			$R_1$ ( $\Omega$ )	$R_2$ ( $\Omega$ )	$R_3$ ( $\Omega$ )	$R_4$ ( $\Omega$ )	$R_5$ ( $\Omega$ )	$C_1$ (pF)
7, 10, 12	1	$A_{vol}$	0	$\infty$	0	$\infty$	$\infty$	0
	2	1	10k	10k	5.0k	390	10k	2200
	3	10	1.0k	1.0k	5.0k	1.0k	10k	2200
	4	100	1.0k	100k	1.0k	10k	10k	2200
	5	1000	1.0k	1.0M	1.0k	30k	10k	1000
	6	1000	1.0k	1.0M	1.0k	0	10k	10
8	1	$A_{vol}$	0	$\infty$	0	$\infty$	0	0
	2	1	10k	10k	5.0k	390	10k	2200
	3	10	1.0k	1.0k	5.0k	1.0k	10k	2200
	4	100	1.0k	100k	1.0k	10k	10k	2200
	5	1000	1.0k	1.0M	1.0k	30k	10k	1000
	6	1000	1.0k	1.0M	1.0k	0	10k	10
13	ALL	1	10k	10k	5.0k	390	10k	2200
14	ALL	10	1.0k	1.0k	5.0k	1.0k	10k	2200
15	ALL	100	1.0k	100k	1.0k	10k	10k	2200
16	ALL	1000	1.0k	1.0M	1.0k	30k	10k	2200

FIGURE 6 – TEST CIRCUIT

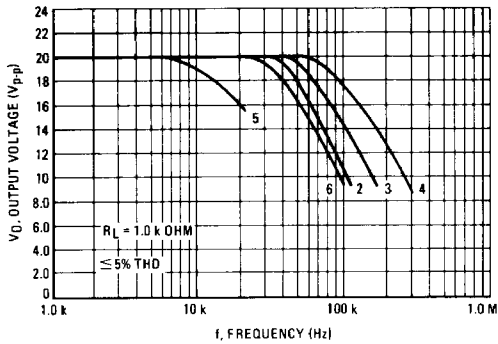


# MC1439, MC1539

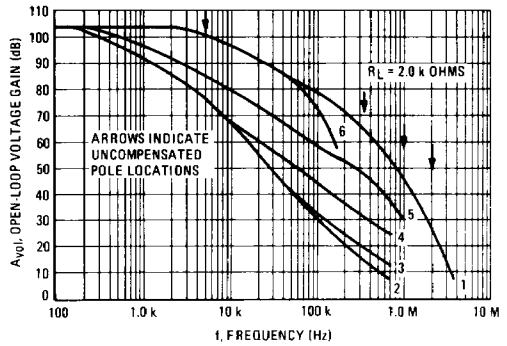
## TYPICAL CHARACTERISTICS (continued)

( $V_{CC} = +15$  Vdc,  $V_{EE} = -15$  Vdc,  $T_A = +25^\circ\text{C}$ , unless otherwise noted.)

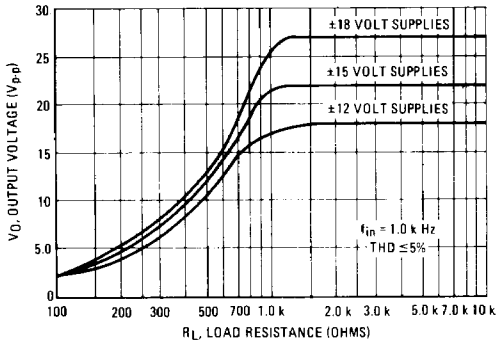
**FIGURE 7 – LARGE-SIGNAL SWING versus FREQUENCY**



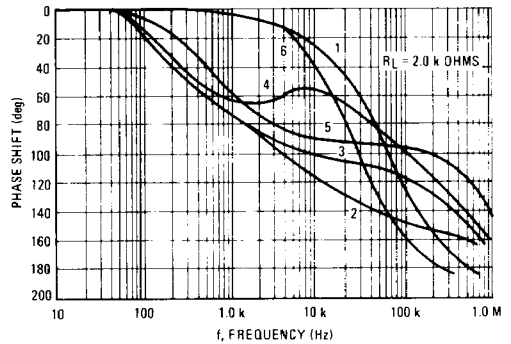
**FIGURE 8 – OPEN-LOOP VOLTAGE GAIN versus FREQUENCY**



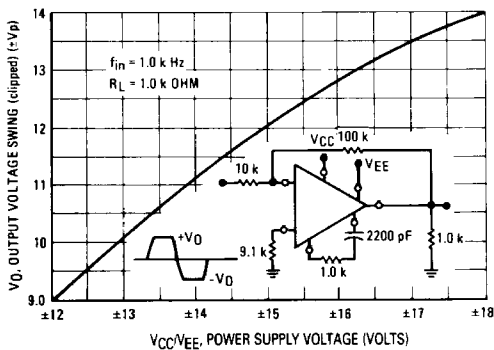
**FIGURE 9 – OUTPUT VOLTAGE SWING versus LOAD RESISTANCE**



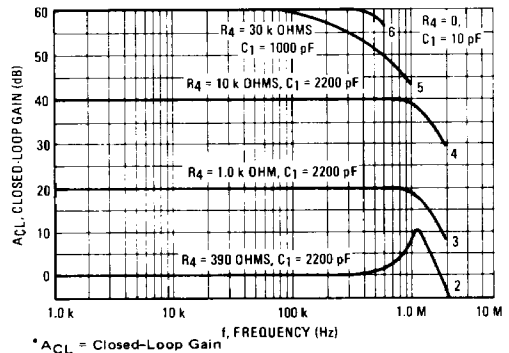
**FIGURE 10 – OPEN-LOOP PHASE-SHIFT versus FREQUENCY**



**FIGURE 11 – OUTPUT VOLTAGE SWING (to clipping) versus SUPPLY**



**FIGURE 12 – CLOSED-LOOP GAIN versus FREQUENCY**



# MC1439, MC1539

## TYPICAL CHARACTERISTICS (continued)

( $V_{CC} = +15$  Vdc,  $V_{EE} = -15$  Vdc,  $T_A = +25^\circ\text{C}$ , unless otherwise noted.)

FIGURE 13 —  $A_{CL} = 1$  RESPONSE versus TEMPERATURE

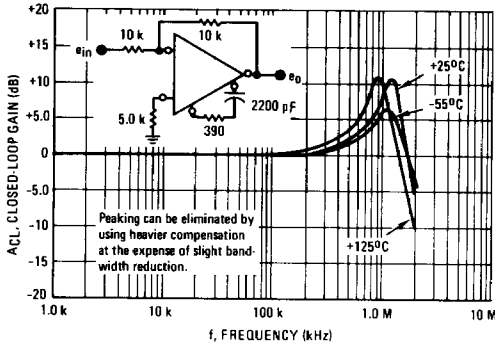


FIGURE 14 —  $A_{CL} = 10$  RESPONSE versus TEMPERATURE

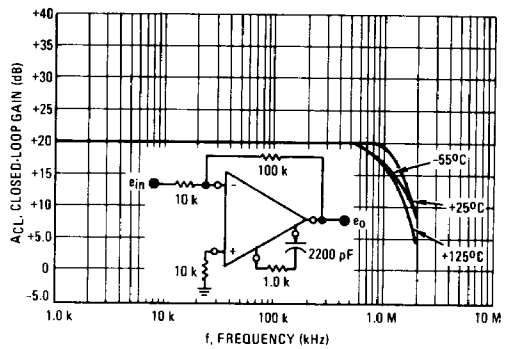


FIGURE 15 —  $A_{CL} = 100$  RESPONSE versus TEMPERATURE

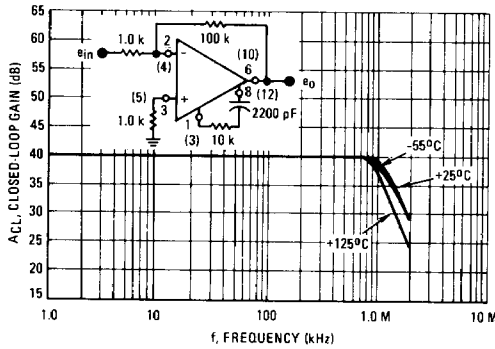


FIGURE 16 —  $A_{CL} = 1000$  RESPONSE versus TEMPERATURE

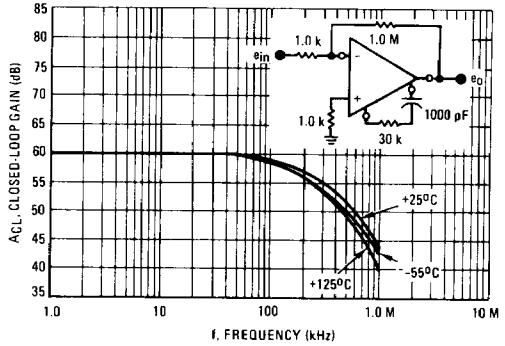
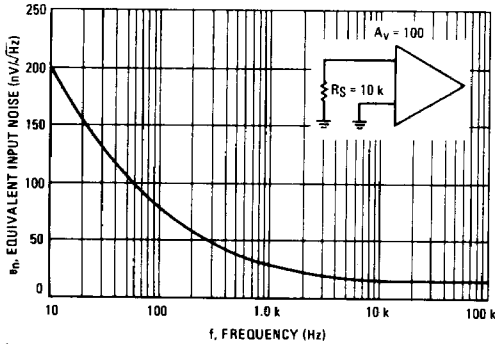
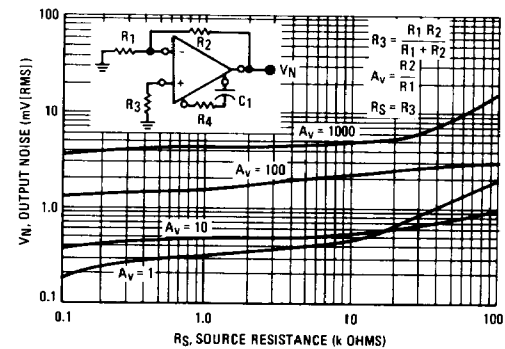


FIGURE 17 — SPECTRAL NOISE DENSITY



\*  $A_{CL}$  = Closed-Loop Gain

FIGURE 18 — OUTPUT NOISE versus SOURCE RESISTANCE

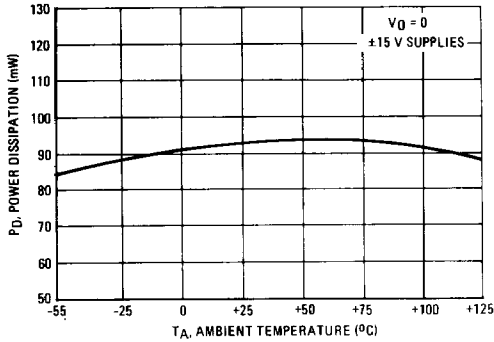


# MC1439, MC1539

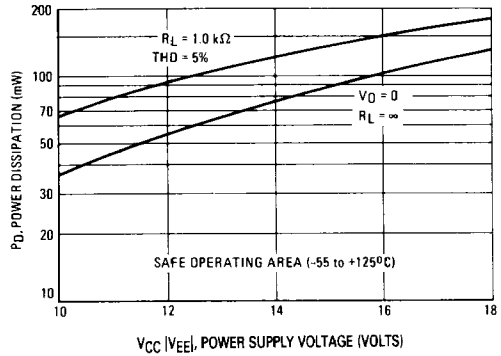
## TYPICAL CHARACTERISTICS (continued)

( $V_{CC} = +15$  Vdc,  $V_{EE} = -15$  Vdc,  $T_A = +25^\circ\text{C}$ , unless otherwise noted.)

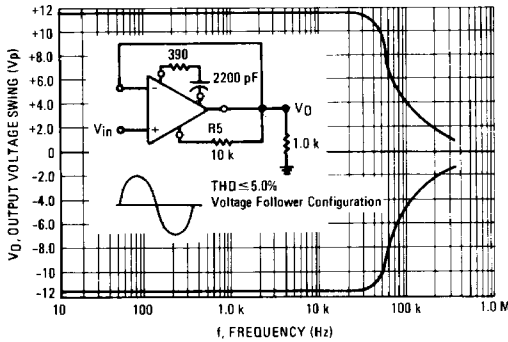
**FIGURE 19 – POWER DISSIPATION versus TEMPERATURE**



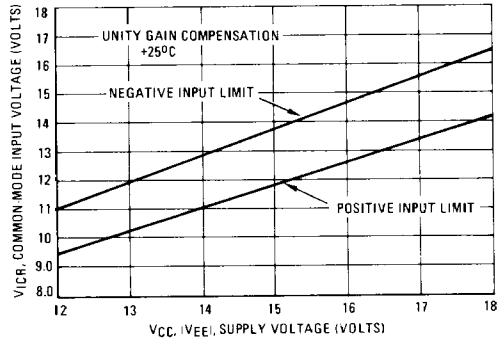
**FIGURE 20 – POWER DISSIPATION versus POWER SUPPLY VOLTAGE**



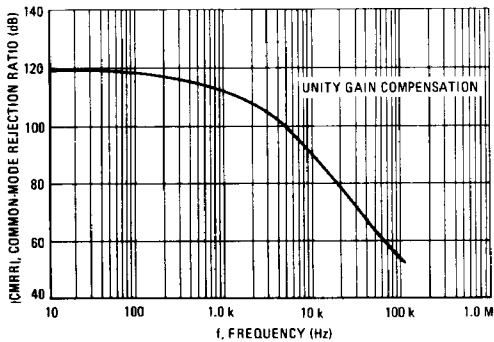
**FIGURE 21 – POWER BANDWIDTH (LARGE-SIGNAL SWING versus FREQUENCY)**



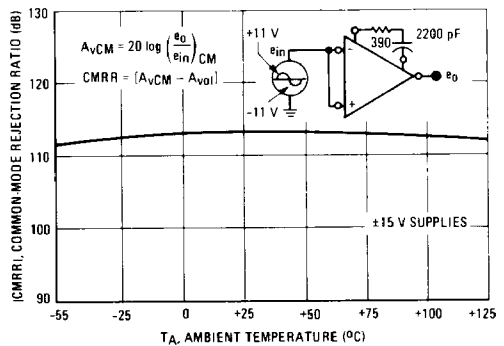
**FIGURE 22 – COMMON-MODE INPUT VOLTAGE versus SUPPLY VOLTAGE**



**FIGURE 23 – COMMON-MODE REJECTION RATIO versus FREQUENCY**

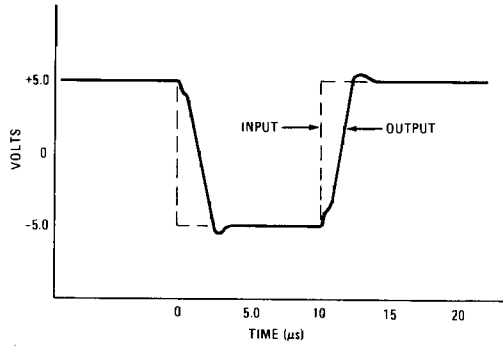


**FIGURE 24 – COMMON-MODE REJECTION RATIO versus TEMPERATURE**



# MC1439, MC1539

FIGURE 25 – VOLTAGE-FOLLOWER PULSE RESPONSE



## TYPICAL APPLICATIONS

FIGURE 26 – VOLTAGE FOLLOWER

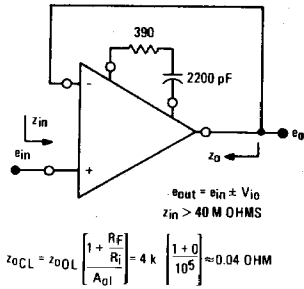


FIGURE 27 – DIFFERENTIAL AMPLIFIER

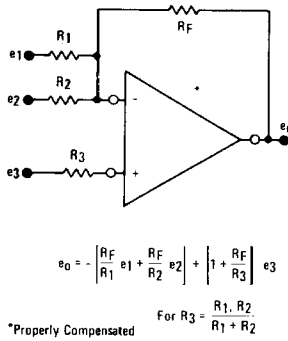


FIGURE 28 – SUMMING AMPLIFIER

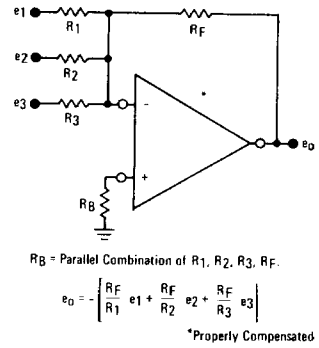
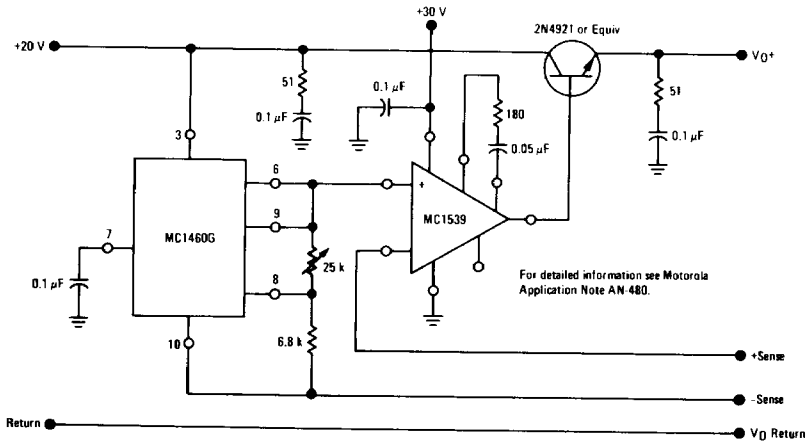


FIGURE 29 – +15 VOLT REGULATOR



TYPICAL APPLICATIONS (continued)

FIGURE 30 – LOAD REGULATION FOR  
CIRCUIT OF FIGURE 29

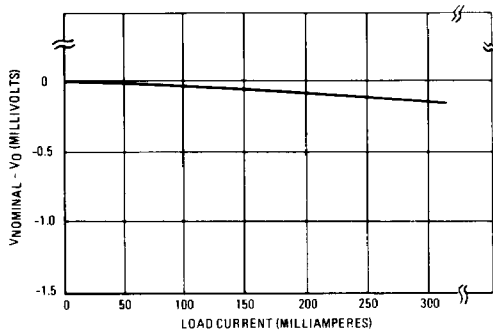


FIGURE 31 – REGULATOR OUTPUT VOLTAGE  
(under pulsed load condition)

